

Food slicers

370 mm Vertical Slicer, belt transmission with tightening arm

ITEM # _____

MODEL # _____

NAME # _____

SIS # _____

AIA # _____

603332 (LUX370BS)

Vertical Slicer with special tightening arm for deli meats, blade diameter 370 mm and cut capacity: 270x270 (square); 270 (round); 340x270 (rectangular), belt transmission

Short Form Specification

Item No. _____

Heavy duty slicer for supermarkets and delis
 Ideal solution for slicing salami and pressed meat, thanks to the special arm.
 Base and main components in high polished satin finished anodized aluminium for long lasting, hygiene and ease of cleaning. The blade is in hollow ground hard chrome with blade guard ring for added protection. Model equipped with cut thickness adjusting knob, top mounted sharpener, cover blade and product deflector - easily removable for cleaning. Ventilated blade drive motor. Poly V-belt drive system for quiet operation and economical service. Removable carriage system permanently lubricated with automatic clutch. IP42 water protection.
 Supplied with blade removal tool and special tightening arm for deli meats.

Main Features

- Manual Vertical slicer with special tightening arm for deli meats.
- Slice thickness from 0 to 24 mm.
- Cut thickness-adjusting knob (millimeter adjustment).
- Belt driven transmission.
- Ventilated blade drive motor designed for continuous use, with Poly V-belt drive system for quiet operation and economical service.
- Removable carriage system permanently lubricated with automatic clutch.
- Top-mounted stone blade sharpener and cover blade easy to remove.
- Supplied with blade removal tool.
- Highest degree of safety in functioning, cleaning and maintenance.
- Cutting capacity for 370 mm model:
 - square: 270x270
 - rectangular: 340x270
 - round: 270

Construction

- Compact design.
- Made in high polished satin finished anodized aluminium. This procedure guarantees high hygienic standards of the parts interested by the cut and resistance to acids, salts and oxidation processes.
- The blade is made of hollow ground hard chrome with blade guard ring for added protection.
- Plexiglass safety hand guard as standard.
- IP42 water protection.

APPROVAL: _____

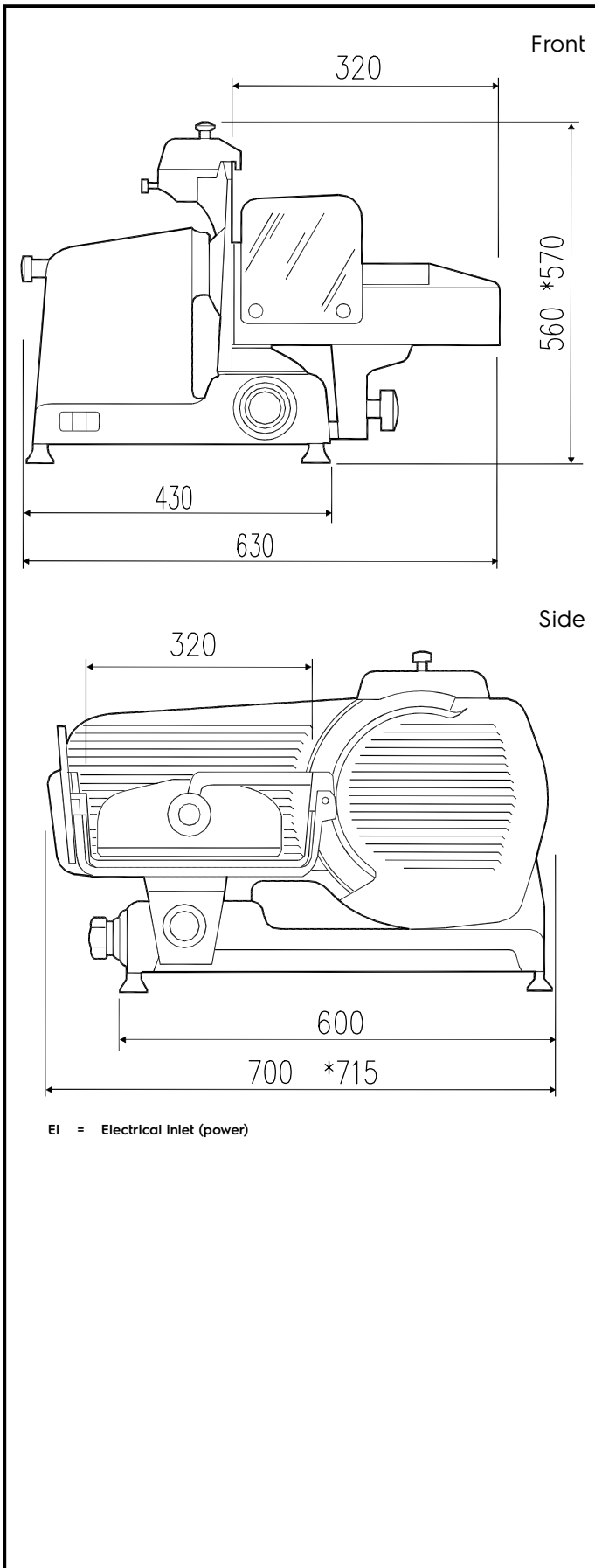

Electric

Supply voltage:	
603332 (LUX370BS)	400 V/3N ph/50 Hz
Total Watts:	0.37 kW

Key Information:

External dimensions, Width:	765 mm
External dimensions, Depth:	630 mm
External dimensions, Height:	570 mm
Net weight (kg):	58